

EHP



Digital Crane Scale Type LDN



User Manual

Index of Contents

Declaration of Conformity	1- 3
1. Safety Instructions	1- 4
2. Keypad	1- 5
3. Key Functions	1- 5
4. Display- Symbols	1- 6
5. Auto Power- Off	1- 7
6. Infrared- Transmitter	1- 8
7. Power Supply of Electronic Device	1- 10
8. Battery Charger / Charging	1- 10
8.1 General	1- 12
8.2 Safety Instructions	1- 12
8.3 Functioning of LED	1- 12
8.4 Putting into Operation	1- 12
8.5 Charge Procedure	1- 13
8.6 Special Instructions to Avoid Sparks	1- 13
8.7 Recommendations for Charging Sealed Lead Acid Batteries	1- 13
9. Accessories	1- 14
9.1 Additional Equipment for Data Transmission	1- 14
9.2 Data Protocols	1- 14
9.2.1 Extended Data Protocol	1- 15
9.2.2 EHP- Standard Data Protocol	1- 16
10. Technical Specifications	1- 17
10.1 Dimensions and Self- Weight	1- 17
10.2 Electrical Properties	1- 18
11. Spare Parts List	1- 19
12. Trouble Shooting	1- 20
12.1 Device Errors	
13. Error Detections	1- 21

Declaration of Conformity

Manufacturer **EHP-Wägetechnik GmbH**
 Dieselstrasse 8
 D-77815 Bühl (Baden), Germany

declares that the weighing instrument

Digital Crane Scale Type LDN

is conform with following harmonized standards:

EN 45501, EN 50081 part1 according to the provisions of the directive 89/336/EEC (electromagnetic compatibility, EMC).

EN 60950 according to the provisions of the directive 73/23/EEC (low voltage directive).

EN 45501 / 8.2 non-automatic and EC approved weighing instruments according to the provisions of the directive 90/384/EEC.

This product is marked with the CE sign.

Bühl, September 2005

Stefan Tisch / Technical Manager

This declaration of conformity is suitable to EN 45014.

1. Safety Instructions

Please read this instruction manual carefully before you set digital crane scale into operation to prevent injuries and protect your digital crane scale against damages.
More safety instructions and warnings could be found directly in the corresponding chapter.

...before setting into operation

- Use the EC type -approved version of this digital crane scale only in weather protected (roof protected) environment, so do not expose it directly sun, rain and snow etc.
- Do not operate this digital crane scale outside the nominal temperature range, e.g. in frost risk environment (less than -10°C) or high heated areas (over $+40^{\circ}\text{C}$), in order to perform best accuracy.
- Check if your crane scale is placed absolutely correct and safe into corresponding hook.
- Respect ACCIDENT PREVENTION REGULATIONS.
- Keep this instruction manual.

...in operation

- Pay attention that scale and load are placed correctly.
- Do not use any solvents for cleaning of the crane scale to prevent defects and damages.

...in case of defects

- Repair work is only allowed to be done by qualified personnel.
- See also chapter TROUBLE SHOOTING and ERROR CODES.

IMPORTANT:

Please be careful with seals and marks on EC type-approved crane scales. If these are damaged, please inform your local office of weights and measures.

Your digital crane scale works by the principle of a high precision strain gauge sensor system with subsequent signal processing.

The user/operator is responsible for the safety of this weighing instrument, i.e. perform a visual control of all tension stressed parts (e.g. ring, hook and shackle) at regular intervals.

In case of visual abrasion of these mounting parts, EHP can offer you a complete technical check according to the German accident prevention regulations.

2. Keypad

Figure 2.1: Keypad / Function Keys



3. Key Functions



Function Key for Scales Power-On

- Switches on the scale.
- Activates the automatic display segment check.
- After testing without error display is automatically set to "0".

Please always switch on scale minimum 5 minutes (warm-up time) before start of weighing. If preload exceeds 20% of crane scales nominal capacity (initial zero-setting range) then only +/- sign is displayed. Normal operating status /weighing mode will be reached again by reducing preload under the 20%-limit and power off-/on-switching.



Function Key for Scales Power-Off

- Switches off the scale.

Power off-/on-switching will reset all crane scale errors (reset function).



Function Key for Test- Routine

Activates during approx. 5 seconds the automatic display segment check and further particulars are displayed.

For approx. 5 seconds display is flashing:

8 8 8 8 8	(Segment Check)
L A H	(Software – Version)
- 1 0 . 0 4	(Version-No.Release)
- - - 0 1	(Scale No.)
C 0 1	(Frequency Channel No.)
H 0 1	(IR- Transmitter Channel No.)



Function Key to store and to delete Tare Values (TARE- Button)

- (Subtractive) TARE function is activated.
 - Current weight value is stored into tare memory.
 - Display shows "0".
 - Net -LED is illuminated.
 - Exit by repressing TARE button and GROSS weight is displayed again.
-



Function Key for Zero-Setting (Zero- Button)





- Sets display to "0" (semi-automatic zero-setting device).
- Zero-setting range: -1...+3% of nominal capacity.



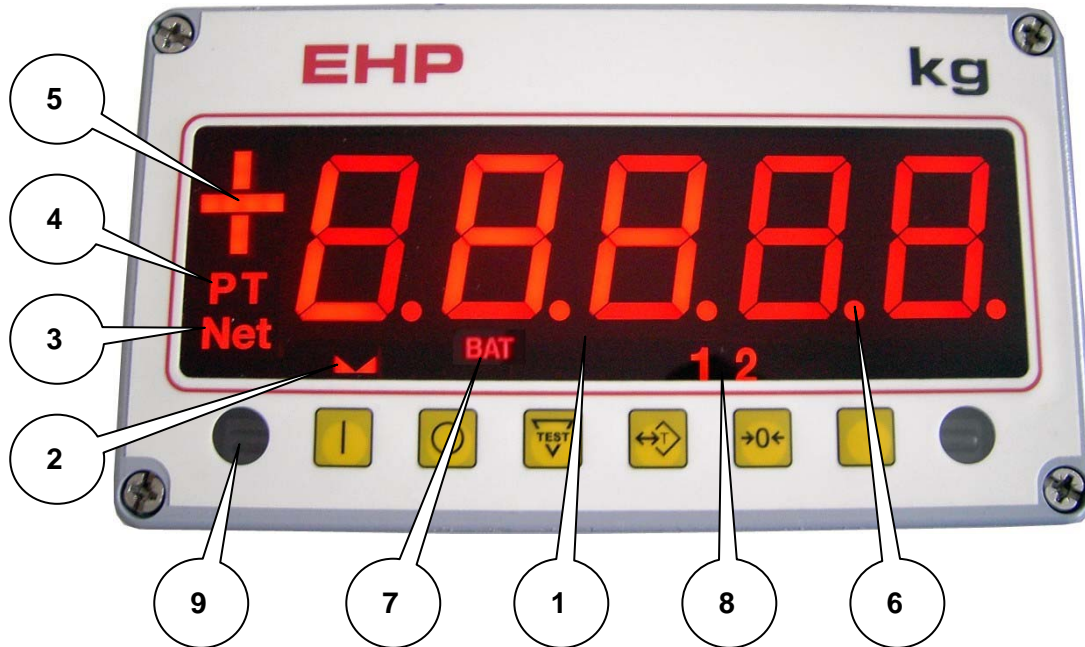

Zero-setting outside semi-automatic zero-setting range and also in active tare weighing mode is **not** possible. Outside of scales 1/4d-range (a quarter of verification interval) only +/- sign is illuminated.

4. Display- Symbols

Figure 4.1: Display



<p>1 - </p>	<p>Display Display consists of 5-digit, 7-segments-LED.</p>
<p>2 - </p>	<p>Dwell Control Indication This sign is illuminated when load on crane scales' hook is motionless AND a correct weighing result is displayed.</p>
<p>3 - </p>	<p>Symbol for Net Weight This symbol is displayed if a tare value is set. The displayed weight is a net weight.</p>
<p>4 - </p>	<p>Symbol for Pre-Tare This Symbol is illuminated with the Net - Symbol, if a Tare value was given. The shown weight value is a net-weight.</p>
<p>5 - </p>	<p>Sign- Symbol Every weight value is displayed combined with its (algebraic) sign.</p> <p>→ Overload Indication: If crane scale is loaded with more than 2e (2x scales verification interval) above the nominal capacity range (see model type indication plate), so display will switch 'dark' and only sign-symbol is displayed. Normal weighing status is reached again when crane scale is unloaded (inside permissible weighing range). Example: Capacity 10t: 2x verification interval 5kg = 10kg, i.e. display is switched ,dark' at a weight of 10010kg. In respect of SATEFY AND HEALTH please do not overload crane scale.</p>

6 - 	<p>Symbol for Decimal Point Is displayed to indicate position of decimal point.</p>
7 - 	<p>Symbol for Battery Control Scales' accumulator is to charge below a battery voltage of 5.4 volts, displayed by a flashing  symbol (empty accumulator). Now you can still work with your instrument for the next 30 minutes (e.g. if it is not possible to pause your weighing process). By then the battery needs to be charged. At a battery voltage of 5.3 volts the scale is switched off automatically to avoid a total discharge and consequently accumulator damage.</p>
8 - 	<p>Symbol for the range Shows range 1 or 2 at Multirange systems.</p>
9 - 	<p>Receiver (diode) of IR- Transmitter</p>

5. Auto Power-Off

This instrument is equipped with an automatic power-off setting device, which is set default = deactivated. In scales setup mode you can choose a power-off setting time between 1...99 minutes. To activate this device or changing of setting time, please contact after sales service.







6. Infrared- Transmitter

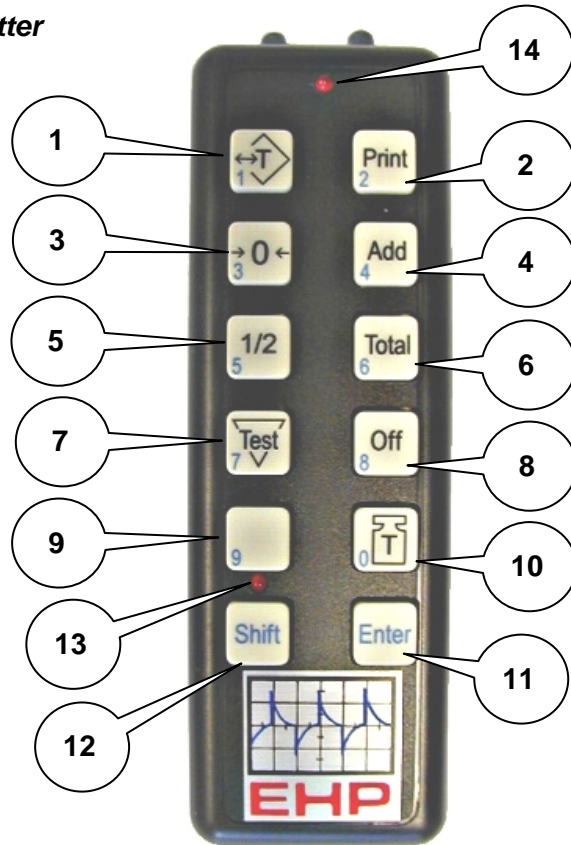







By means of IR-transmitter you can activate further additional functions beside scale keypad functions.

Change transmitters' batteries (4pcs. a 1.5V Type AAA, Micro, LR03, AM4, MN2400) when operating distance is getting insufficient (less than approx. 20m).

Picture 6.1: IR-Transmitter



1 - 	Press button to input and delete tare values (TARE- Button) This key has same function as on scales' keypad.
2 - 	Press button to activate the PRINT- Function (PRINT- Button) Through this scales display value (plus additional data) will be transmitted via UHF radio to receiver units (see accessories), e.g. a single print out will be activated on the integrated printer of TELEDATA receiver unit.
3 - 	Press button for zero-setting (Zero- Button) This key has same function as on scales' keypad.
4 - 	Press button to activate the ADD- Function (Add- Button) Press this button if several different single weights within one charge should be collected resp. added. Scales display value (plus additional data) will be transmitted via radio to receiver units, e.g. a single weight registration within a total print out will be activated on TELEDATAs integrated printer.
5 - 	Non-active , only possible in combination with dual-range scales.
6 - 	Press button to activate Print Total- Function Through this scales display value (plus additional data) will be transmitted via UHF radio to receiver units (see accessories), e.g. a total print out (total of all single weight values will be activated on the integrated printer of TELEDATA receiver unit (addition of all single weight registrations transmitted by ADD- Function).
7 - 	Press button to activate Test Routine (Test- Button) This key has same function as on scales' keypad.

8 - 	<p>Press button for scales' (remote) power- off</p> <p>Press this button to switch off the scale by remote control. A re-power-on is possible by pressing any button of IR- transmitter or by pressing function key  on scales' keypad. This function could be set deactivated by factory or in scale setup.</p>
9 - 	<p>Non-active</p>
10 - 	<p>Non-active</p>
11 - 	<p>Enter- Button</p> <p>This press button transfers a code (max. 5 digits) which is entered by numeric keys together with actual weight value via radio / RS232 (see accessories) to receiver devices.</p>
12 - 	<p>Shift- Button</p> <p>Press this button to activate numeric keys. Now you can input any numbers (max. 5 digit code) between 0...9 (blue numbers).</p>
13- 	<p>Symbol for active numeric keys</p> <p>If this LED is illuminated then you can select the (blue) numbers of IR- transmitter numeric block (see also Shift- Button).</p>
14- 	<p>Transmission- Symbol</p> <p>Transmitting remote control is displayed by flashing LED.</p>

Note:

If functions: **Print**, **Add** and **Total** are activated by IR-transmitter, their characters are also displayed on scale. Activating of function keys is now locked during the next approx. 5 seconds in order to prevent transmitting several commands by mistake.

7. Power Supply of Electronic Device

Electronic device is protected by a fast-acting fuse 1A (5 x 20mm DIN 41571).
Crane scale type LDN is powered by a special battery 6 volts.

Picture 7.1: Accumulator with open battery housing



WARNING:

Avoid setting in false connection or inverse-polarity or connecting of another power supply as accumulators supplied by manufacturer.

Colour code of supply leads: **+ / plus = red, - / minus = black**

8. Charger / Charging

It is only allowed to charge the accumulator by original provided EHP- charger, either by using scales' charging plug (picture 8.2) or directly (picture 8.1). The charger is equipped with an electronic charging current limiting so that it is not possible to overcharge the accumulator. Charging current control is indicated on chargers' front panel (All connectors are protected against inverse-polarity).

Picture 8.1: Charger and Battery charging

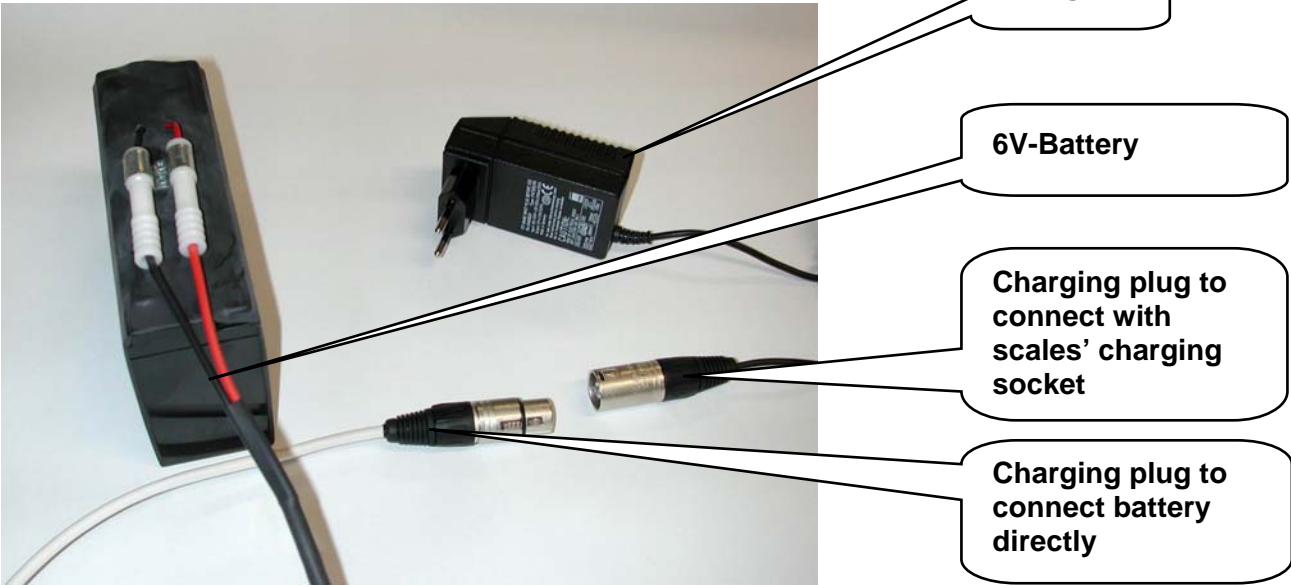

Picture 8.2: Scales' Plug Socket (Bottom side of scales' battery housing)

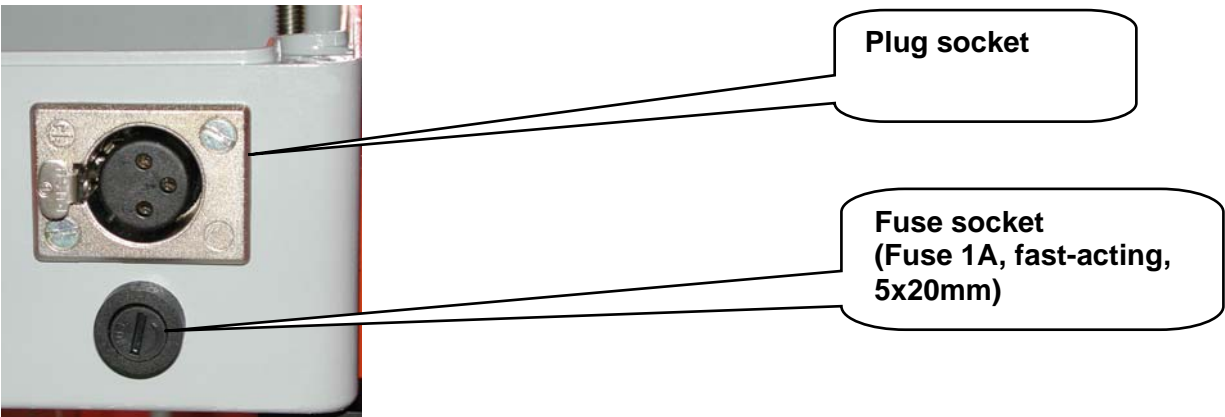

Picture 8.3: Scales' plug socket with charging plug

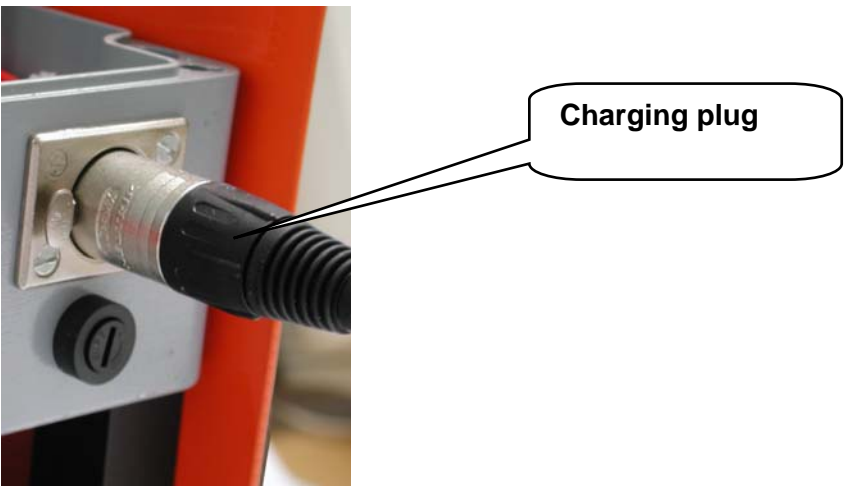

8.1 General

The charger is designed in primary switch mode technology. This provides a constant DC voltage which guarantees a long lifetime of maintenance free sealed lead acid batteries. A holding device for wall mounting will be found on the back side of the charger.

8.2 Safety Instructions

The charger is especially designed to charge maintenance free lead acid batteries. The charger housing can only be opened and maintained by authorized personnel. Unqualified opening may cause damages to charger and will cancel guarantee. Operation with an opened housing is strictly prohibited. Only a qualified technician is allowed to replace the fuse. The charger can only be operated if sufficient cooling is assured. The charger can only be operated in closed rooms and must be protected against moisture.

8.3 Functioning of LED



LED light red	Battery is connected charger is in loading mode with 1,6A
LED light green	Battery is charged, charger is in float-charge mode (max 50 mA) Battery can't be overloaded.

8.4 Putting into operation

Compare the rated voltage of type plate of charger with the rated voltage of the battery. The charger will be connected with the plug socket of crane scale to charge the battery I the scale. To charge the battery outside the scale, an adapting cable is needed (optional) see picture 8.1

8.5 Charge Procedure

When charging the battery, the LED is burning green.

8.6 Special Instructions to Avoid Sparks:

1. Connect mains supply without battery connection.
2. Disconnect mains after a short period of time.
3. Connect battery with correct polarity.
4. Connect mains supply.

8.7 Recommendations for charging sealed lead acid batteries

Charge/ Discharge

- Before delivery of your crane scale type LDN 6V-battery was already charged for 12 hours and is therefore instantly ready to operate.
- Charge after each discharge even after partly discharge.
- Never store a discharged battery.
- A completely discharged battery must be charged for min. 16 hours.
- If charging time is below 16 hours for more than 3 days then charge one time for 24 hours to equalize the poor charging.
- Ambient charging temperature should range between 10°C and 30°C.

Before longer storage periods (2 possibilities)

A: Disconnect battery from charger and store it fully charged.

! CAUTION: Charge battery for min. 36 hours before storage period of 3 months or more!

B: You can leave battery on charge for an unlimited time (trickle charge). It is recommended to store battery at a cool place.

High ambient temperatures

Charging at temperatures above 30°C is not recommended. Your charger is adjusted with a charging voltage valid for 20°C.

Low ambient temperatures

Charging below 10°C is not recommended. At low temperatures the available capacity is reduced.

Deep discharge

Try to avoid deep discharges. If a deep discharge occurred charge battery as soon as possible for 24 hours.

Maintenance

Wipe battery surface from time to time with a dry and clean cloth.

9. Accessories

9.1 Additional Equipment for Data Transmission

Crane scale type LDN can be equipped with a radio transmitter for data transmission on receiver units (Teledata, Telebox Plus, Greybox und Large Display) or connection to computer directly:

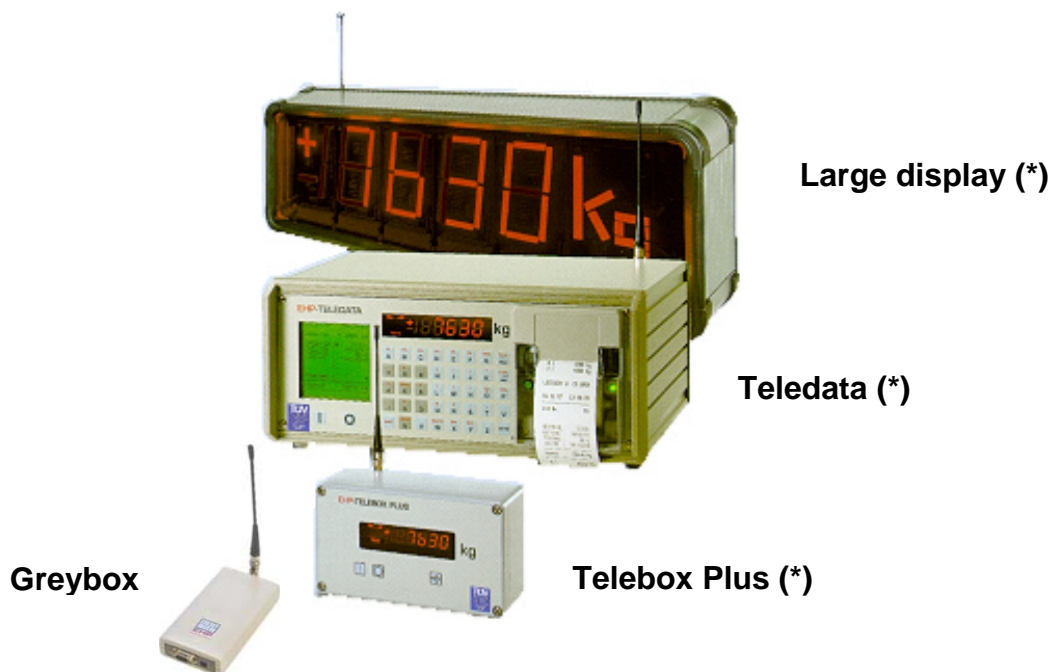

(*) Not available in all countries.

Note:

The connection of additional equipment is under control of a metrological verification, i.e. it is not allowed to refer received and printed data to a third party.

9.2 Data Protocols

9.2.1 Extended Data Protocol

The extended data protocol (23byte) which is send via radio transmission / serial interface RS232/ V24 (9600 baud, cyclical, approx. 1 transmission per second), has following data format:

- 1 Startbit
- 8 Databit
- 1 Stopbit
- No parity

Byte #	ASCII	Description
1.	S	Start sign
2.	0	No decimal point (e.g. 19520)
	1	One position after decimal point (e.g. 1952.0)
	2	Two positions after decimal point (e.g. 195.20)
	3	Three positions after decimal point (e.g. 19.520)
	4	Four positions after decimal point (e.g. 1.9520)
3.	blank (20H)	No sign
	+	Plus
	-	Minus
4.	Digit 5	5 th digit (from the right) of weight value
5.	Digit 4	4 th digit (from the right) of weight value
6.	Digit 3	3 rd digit (from the right) of weight value
7.	Digit 2	2 nd digit (from the right) of weight value
8.	Digit 1	1 st digit (from the right) of weight value
9.	B	Scale Tare OFF (Gross- Weight)
	N	Scale Tare ON (Net- Weight)
10.	E	Single range scale
	1	Range I
	2	Range II
11.	0	No standstill
	1	Standstill
12.	0	No button is pressed at IR-transmitter
	1	
	2	Button 2 (Print- Button)
	3	
	4	Button 4 (Add- Button)
	5	
	6	Button 6 (Total- Button)
	7	
	8	
	A	Scale is switched off manually

	X E C	Scale is switched off automatically by auto power-off Transmission error Test
13.	V H L	Battery of scale is full charged Battery of scale – pre-warning Battery of scale – discharged/ empty
14.	(1 – 99)	Digit 1 of scale no.
15.	(1 – 99)	Digit 2 of scale no.
16.	(X)	Not in use
17.	N J G	No overload Overloaded Out of initial zero-setting range
18.	Digit 5	5 th digit (from the right) of numerical input / IR-transmitter
19.	Digit 4	4 th digit (from the right) of numerical input / IR-transmitter
20.	Digit 3	3 rd digit (from the right) of numerical input / IR-transmitter
21.	Digit 2	2 nd digit (from the right) of numerical input / IR-transmitter
22.	Digit 1	1 st digit (from the right) of numerical input / IR-transmitter
23.	03 H	End of block (03 Hex)

9.2.1 EHP- Standard- Protocol

The standard-protocol (18 byte) is compatible completely to the transmission with additional EHP-receiver units (Teledata, Telebox Plus and Large Display). In comparison to the extended protocol byte #18... #22 (numerical code) are missing.

10. Technical Specifications

10.1 Dimensions and Self-Weight

Dimensions in millimeter

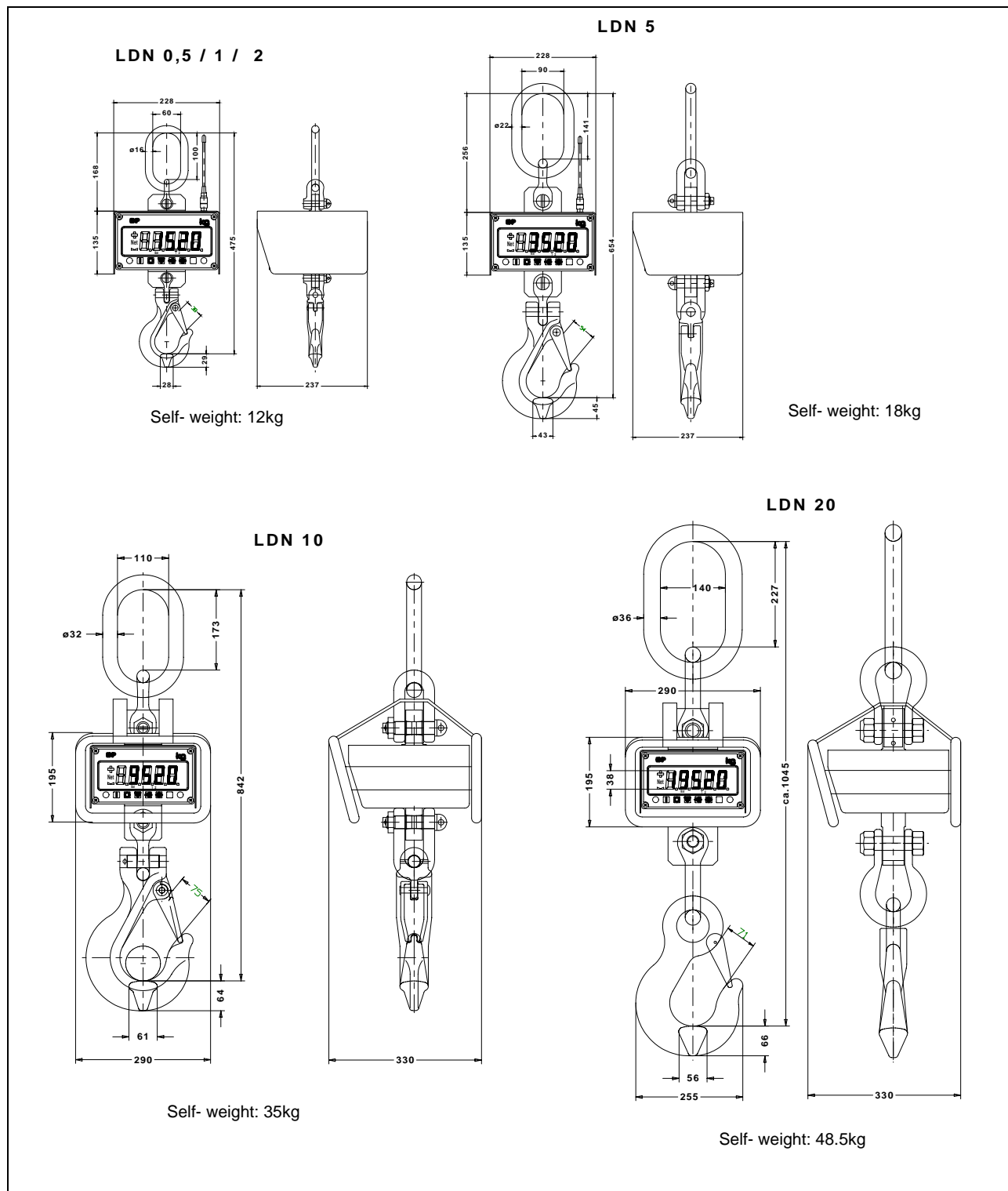

Technical variations may cause the specifications to change without notice

10.2 Electrical Properties

Power supply of electronic device	6V DC maintenance-free lead acid battery 14.4Ah
Minimal battery voltage	5.3V DC
Power supply of IR- transmitter	4pcs. a 1.5V Type AAA, Micro, LR03, AM4, MN2400
Operation distance of IR- transmitter	approx. 35m with angle < 20°
Minimal operation time of scale	80 hours
Power supply of battery charger	230V AC, 50/60Hz
Nominal charging time	< 12 hours
Maximum number of verification intervals	2500 divisions (acc. EC type-approval certificate)
Nominal temperature range	-10°C...+40°C
Temperature range	-10°C...+50°C
EEC protection class	IP 54

11. Spare Parts List

For spare parts please contact your next representative service center or manufacturers' after sales service.

Part No.	Part
69009	Battery charger 6V / 1,6A
69268	Battery 6V / 12Ah
70972	IR – transmitter
72061	Electronic pc-board LDN
52525	Fast-acting fuse 1A, 5 x 20mm, DIN 41571
72204	Front panel LDN
56639	Protection shield LDN 0.5-5t
61578	Protection shield LDN 10t
72237	Protection shield LDN 20t
72215	Ram protection LDN 10t / 20t
72216	Ram protection LDN 5t
66319	Load cell LD 0.5-2t
74690	Load cell LD 5t
69355	Load cell LD 10t
72270	Load cell LD 20t

12. Trouble Shooting

Repair work on digital crane scale LDN is only allowed by qualified technical personnel.

If the advice does not bring any success, please contact the after sales service.

12.1 Device Errors

Fault	Cause	Corrective
Display is dark	No power	Please check if scale is switched on. Please check if battery is charged. Please control the fuse.
(Only approved version) Display shows for a short time '+' sign after switching on.	Scale is out of initial zero-setting range	Switch off scale, unload the scale and switch on again.
(Only non-approved version) Display flashes	Scale is overloaded	Reduce the load inside the nominal weighing range (see type plate on right side of the scale)
Display shows only the '+' sign	High overload	Reduce the weight to a permissible value
It is not possible to switch off the scale.	Electronic error	Remove fuse and insert it again, switch on scale.
Scale can not set to zero.	Scale is outside zero-setting range	Please reduce the load inside the zero-setting range.
	Scale is set into tare weighing mode, Net- LED is illuminated.	Press TARE- Button again to quit tare weighing mode.

13. Error Detection

Automatic error diagnosis routines verify cyclically the proper function of the weighing instrument and ensure a faultless operation; a permanent visual control is not necessary anymore. In case of an error, it will be displayed in form of an error code (see table). Therefore weighing is no longer possible. Scale will automatically be switched off after approx. 5 seconds.

Error Code	Cause	Corrective
02	Amplifier input voltage is to low.	Switch off the scale and switch on again. Please contact after sales service.
03	Amplifier input voltage is to high.	Switch off the scale and switch on again. Please contact after sales service.
04	AD-Converter Error	Switch off the scale and switch on again. Please contact after sales service.

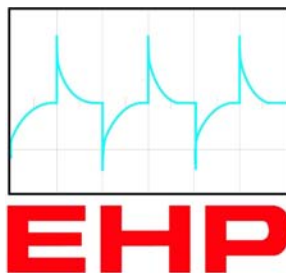

EHP Wägetechnik GmbH

Dieselstraße 8 • D-77815 Bühl (Baden)

Tel. +49 (0) 7223 93660 • Fax +49 (0) 7223 30140

E-mail: info@ehp.de • www.ehp.de

servizio post-vendita

after sales service

service après-vente

Kundendienst

servicio post-venta

serviço pós-venda

Tel. +49 (0) 7223 9366 0 • Fax +49 (0) 7223 30140
